

# Acura® *electro*

your electronic choice

## Operating instructions Models 926, 936 and 956

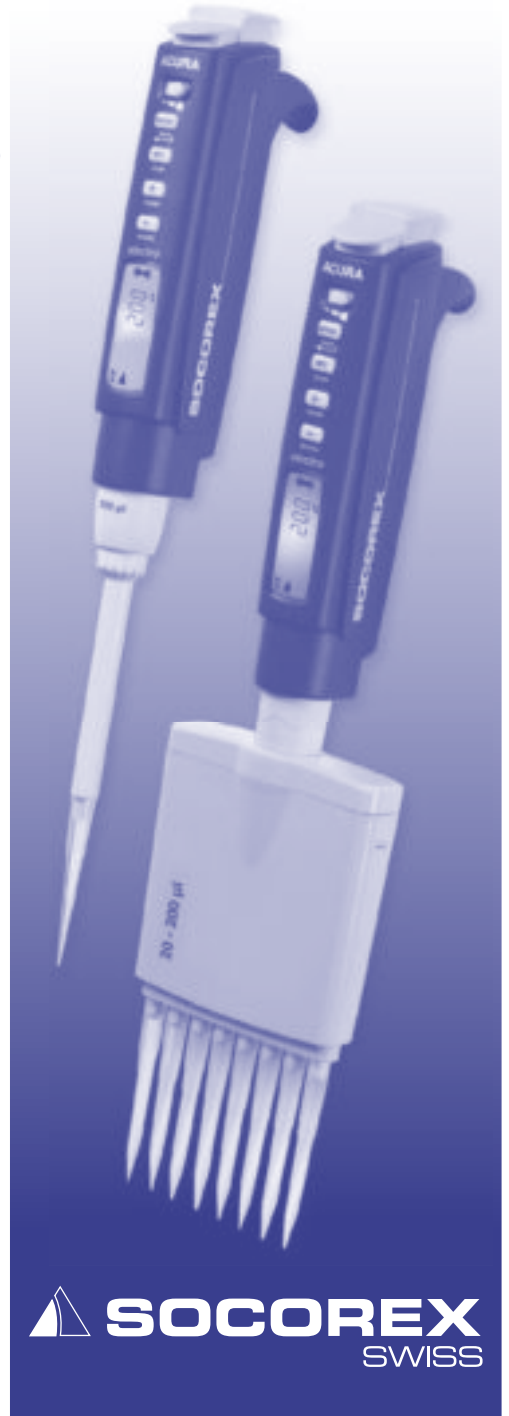

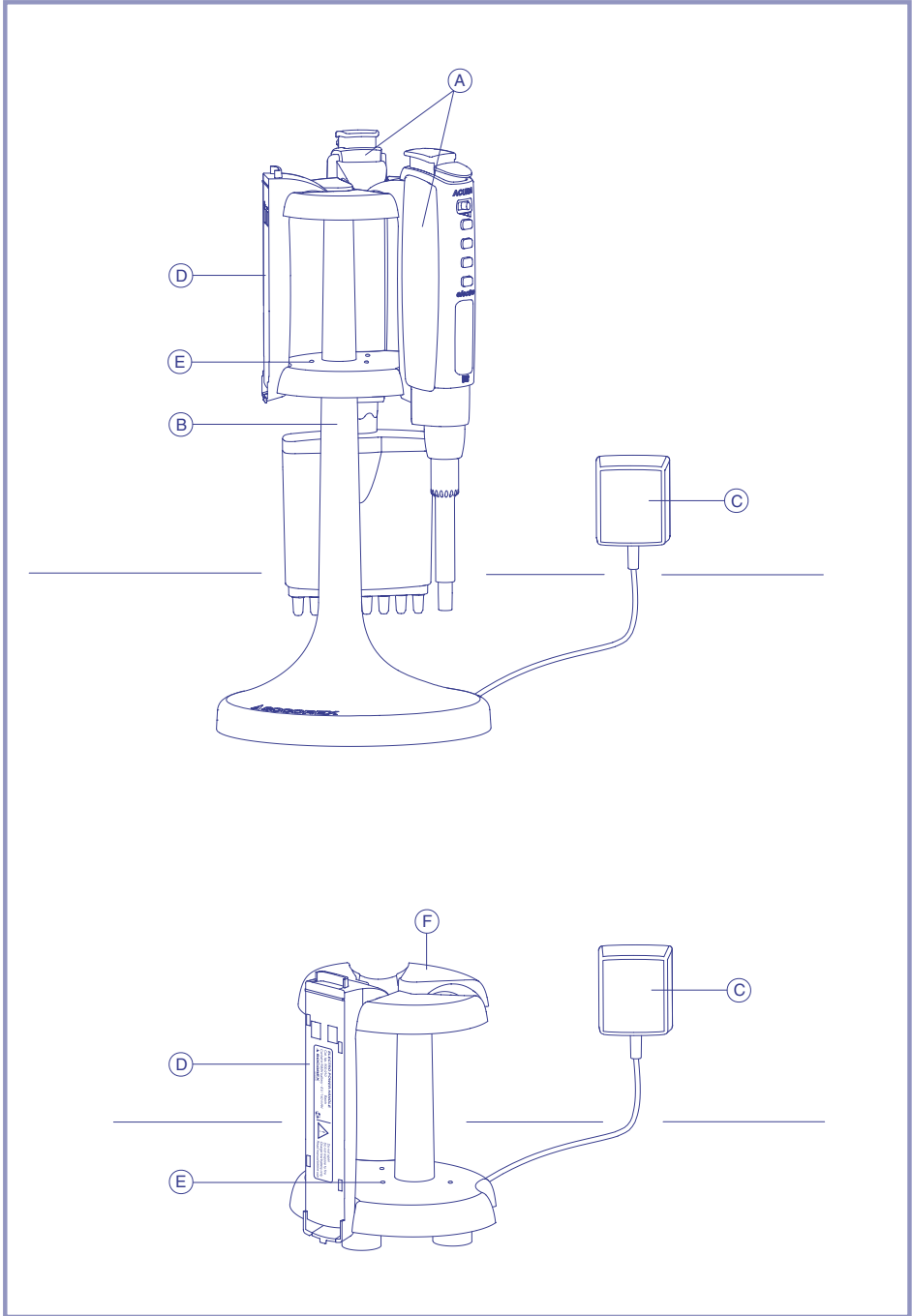

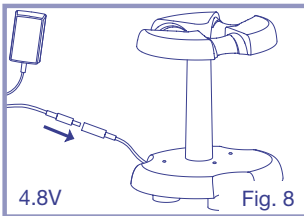
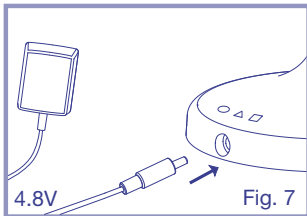
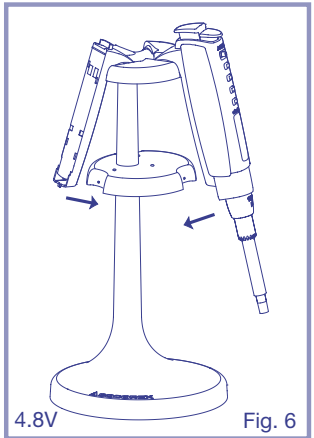
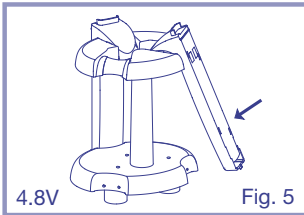
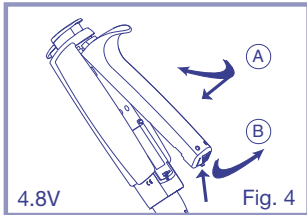
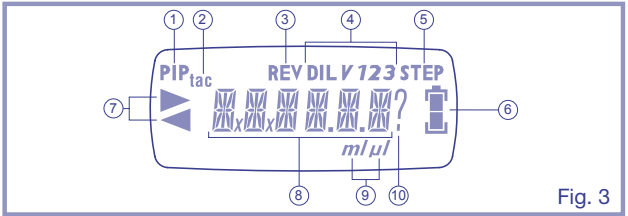
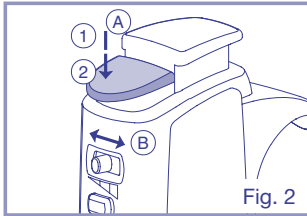
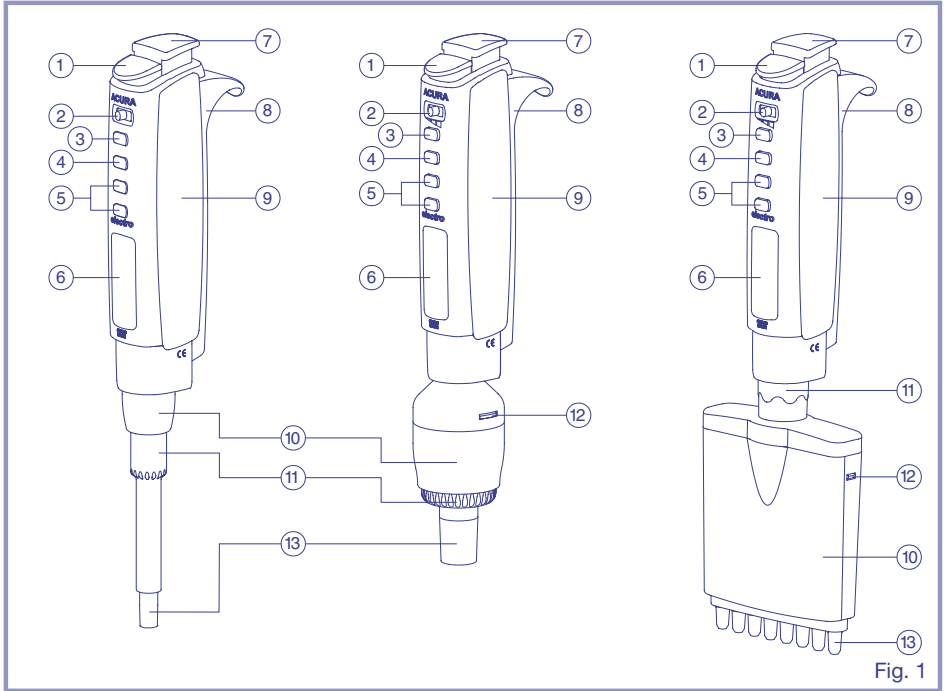

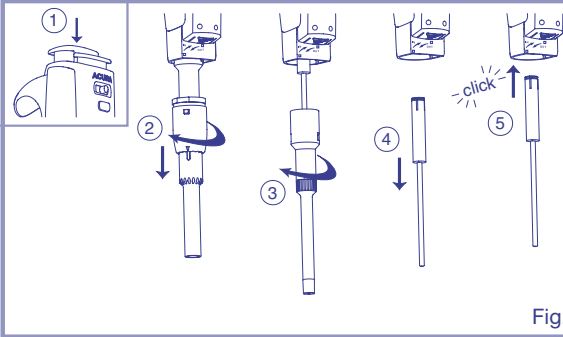

Fig. 9

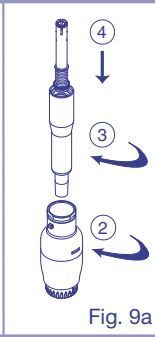

Fig. 9a

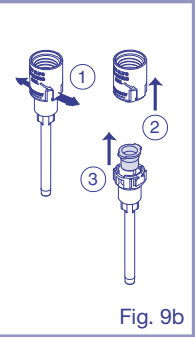

Fig. 9b

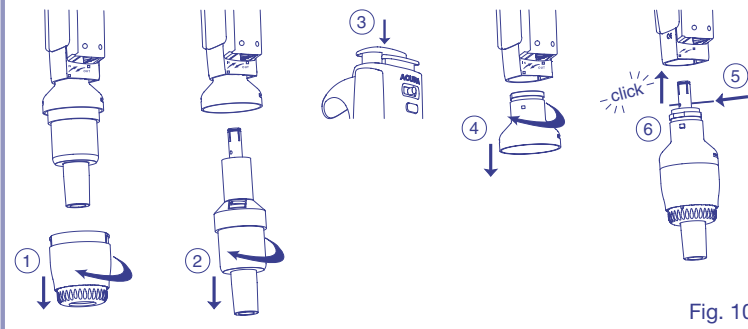

Fig. 10

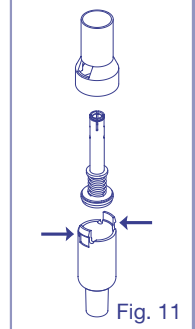

Fig. 11

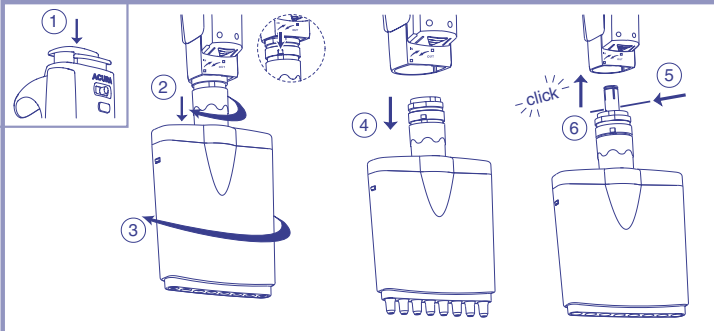

Fig. 12

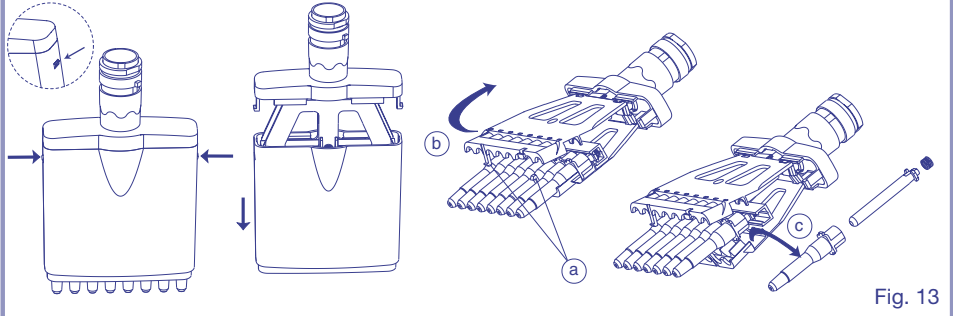

Fig. 13

# TABLE OF CONTENTS

<b>Foreword</b>	<b>3</b>
<b>Safety precautions and application limits</b>	<b>4</b>
Pipette handling	
Maintenance and sterilisation	
Charging stand, power handle and power supply	
<b>Instrument description</b>	<b>5</b>
View	
Keys and functions	
Start button	
LCD display	
Power handle	
Optional charging stands	
Power supply	
<b>Use of the instrument</b>	<b>6</b>
Supply contents	
Inserting power handle	
Replacing power handle	
Charging power handle	
<b>Parameter setting</b>	<b>7-19</b>
Holding the electronic pipette	7
Left or right display reading	7
Beeping sound	8
Forward mode, programming and pipetting	9
Reverse mode, programming and pipetting	10
Stepper mode, programming and pipetting	11-12
Stepper mode, excess volume control	13
Stepper mode, interruption of pipetting sequence	13
Dilution mode, programming and pipetting	14-15
Dilution mode, interruption of pipetting sequence	16
Tactile mode, programming and pipetting	17-18
Tactile mode, interruption of pipetting sequence	18
Mixing	19
Pipetting cycle counter	19
<b>Operation</b>	<b>20-24</b>
Selection of pipetting speed	20
Charge level of power handle	20
Changing volumetric module	21-22
Programming of volumetric module	23
Correction of volumetric module selection	23-24
Use of Pasteur pipette	24
Adjustment of tip ejector	24
<b>Maintenance and sterilisation</b>	<b>26-27</b>
Cleaning	26
Replacement of tightness parts	26-27
Sterilisation	27
<b>Instrument calibration</b>	<b>28-29</b>
Calibration increments	28
Calibration procedure	28-29
<b>Trouble shooting</b>	<b>30-31</b>
Error messages	30
Instrument reset	30-31
Other failures	31
<b>Performance</b>	<b>32-33</b>
<b>Warranty</b>	<b>34</b>
<b>Ordering information</b>	<b>36-38</b>
Instruments, accessories and tips	
<b>Exploded drawings</b>	<b>IV-VII</b>



## Foreword

Congratulation for choosing a Socorex instrument. You purchased a superior quality product built to last, and to satisfy you for a long time.

The Acura® *electro* pipette allows precision liquid handling without hand fatigue. The microprocessor-controlled instrument includes an extended life NiMH battery pack for high performance.

### Main user benefits

- Ergonomic, optimized weight and hand balance for perfect working comfort
- User-friendly through intuitive software programme, easy to use
- Display selection for left or right-handed user
- Extended pipetting autonomy, instant exchange of battery pack eliminates interruption of work
- Autoclavable volumetric modules are interchangeable on single control unit
- Instrument software covers all volume modules
- Justip™ adjustable ejector facilitates fitting and ejection of tips

Before using the instrument for the first time, instructions must be read carefully. Special attention should be paid to the safety precautions and application limits. Keep this booklet for future reference.

# SAFETY PRECAUTIONS AND APPLICATION LIMITS

Before using the instrument for the first time, read the safety precautions and application limits carefully. Socorex will not assume any responsibility for problems related to erroneous use of the instrument.

## Pipette handling

- Refer to and follow regulations about handling of potentially hazardous reagents
- Before use, check tip/nozzle tightness and working condition of the instrument
- Emergency stop: press the “set/stop” key to interrupt immediately any plunger movement in stepper, dilution and tactile modes
- Do not use the Acura® *electro* in areas where there is explosion or flame hazard
- Do not place the Acura® *electro* on charging stand with a filled tip
- Do not let liquid penetrate inside the pipette housing (upper assembly)
- Change volumetric module **only** with charged power handle in place
- Instrument should not be used at temperatures below 5°C and over 40°C
- This product should be used only for its intended purpose
- Mind possible hand-fatigue during serial pipetting and its potential medical consequences (such as repetitive strain injuries, RSI)

## Maintenance and sterilisation

- Do not use aggressive solutions (such as acetone) to clean volumetric modules. Use water or alcohol (ethanol) instead
- Only the volumetric module (lower assembly) is autoclavable at 121°C. The control unit (upper assembly) is **not** autoclavable
- No liquid must penetrate inside the pipette control unit (upper assembly) nor the charging stand
- Refer to instructions for any operation (maintenance, change of volumetric modules) carried out on the instrument
- Servicing of control unit must be done by authorised, trained personnel only
- Use only Socorex original parts and accessories (power handle, pipette tips, spare parts)

## Charging stand, power handle and power supply

- Power handle (battery) must be completely charged before first use
- Power handle can be charged either separately, or when placed on the instrument
- For best power handle durability, avoid re-charging when “low bat” is not lit
- Do not use any power supply other than the original one supplied by manufacturer
- Do not damage electrical cord or plug of charger with heavy or sharp items
- Do not expose pipette, power handle, charging stand or power supply to heat or liquid spillage
- Remove power handle from the instrument if it is stored for a long period of time; this prevents discharge of the batteries
- Recycle used or damaged power handle according to applicable local laws
- The power handle will have longer life span if the above instructions are followed carefully



# INSTRUMENT DESCRIPTION

The Acura® *electro* is a motorized, microprocessor controlled air displacement pipette. Energy is provided by a long life NiMH battery pack located in the pipette handle. This power handle can be replaced with a fully charged one within seconds, thus ensuring continuous work-flow without loss of set parameters. Acura® *electro* 926 XS models allows precise and reproducible pipetting within 0.1 µL to 1000 µL. Acura® *electro* 936 macromodels cover volumes from 0.1 to 10 mL. Multichannel Acura® *electro* 956 with 8 and 12 channel range between 0.5 µL and 350 µL. All volumetric modules (lower assemblies) are interchangeable on the same control unit (upper assembly). The Justip™ ejection system provides height adjustment of the single and multichannel tip ejector.

## View (see p. I)

- A) Acura® *electro* pipettes
- B) Charging stand for electronic pipette and power handle
- C) Power supply with cord
- D) Power handle
- E) Charging LED
- F) Battery charging stand

## Keys and functions (fig. 1)

- 1) 2 positions start button
- 2) 3 positions speed selector
- 3) Programming key (mode) for choosing:
  - Pipetting modes
  - Aspiration in tactile mode
  - Side of display reading
  - Installed volumetric module
- 4) Set key for entering selection or emergency stop
- 5) Selection keys (+/-) for choosing:
  - Volumes
  - Calibration settings
  - Volume ranges
  - Left/right display reading
  - Cycle counter
  - Mixing
- 6) LCD display (see fig. 3 for details)
- 7) Tip ejector button
- 8) Power handle
- 9) Control unit
- 10) Interchangeable volumetric module
- 11) Justip™ ejection system
- 12) Clips
- 13) Pipette nozzle

## Start button (fig. 2A)

The start button has two working positions:

- Press until first stop (1) to work at the slow pipetting speed
- Press until second stop (2) to work at the selected pipetting speed

## LCD display (fig. 3)

- 1) Forward pipetting mode
- 2) Tactile pipetting mode
- 3) Reverse pipetting mode
- 4) Dilution mode, volume sequence (vol. 1, 2 or 3)
- 5) Stepper mode
- 6) Battery level indicator
- 7) Pipetting: aspirating or dispensing
- 8) Digits for volume display or messages
- 9) Current volume units (µL or mL)
- 10) Sign requiring user input (selection or validation)

## Power handle (fig. 4)

The rechargeable power handle contains NiMH batteries of 300 mAh/4.8V. Charge a fully discharged power handle in less than 1.5 hours.

## Optional charging stands (fig. 5 and 6)

- Charging stand for 4.8V Acura® *electro* and power handles (fig. 6) with 3 charging positions
- Compact battery charging stand (fig. 5): allows to simultaneously charge up to 3 power handles

## Power supply (fig. 7 and 8)

- Input: 100-240, 50/60 Hz
- Out put: 7.5 VDC
- Supplied with electrical cord and plug
- Various plug styles available depending on user location. See ordering information

# USE OF THE INSTRUMENT

## Supply contents

Accessories supplied with the Acura® *electro* may vary, depending on country. Check exact contents on packaging label. All elements also available separately. Refer to chapter “Ordering information” for more details.

**Note:** *Keep original packaging for adequate instrument protection during future transport or shipment.*

## Inserting power handle (fig. 4A)

The power handle fits at the back of the pipette control unit. Insert and click in as shown. The initialisation starts automatically, followed by a self-calibration test. The display shows “RE-CAL”.

**Note:** *Charge power handle completely before first use.*

## Replacing power handle (fig. 4B)

To remove the handle from control unit, press lock trigger located at the bottom of the handle and lift gently.

**Note:** *Pipetting data are kept in memory even during battery change. They will show again automatically upon re-inserting power handle.*

## Charging power handle (fig. 5 and 6)

The power handle can be charged in three different ways:

- 1) Attached to the *electro* pipette and placed on the charging stand
- 2) Alone, placed on charging stand
- 3) Alone, placed on the compact battery charging stand (to be ordered separately)

The red LED goes on when charging a power handle.

The green LED indicates that charging is completed and goes on stand by with minimal energy consumption.

Maximal battery capacity is obtained after a few full charging/discharging cycles.

At maximum capacity, power handles allow for over 3000 forward pipetting movements (full plunger stroke on a single channel micropipette) without recharging.











**Notes:** *If unused for 10 minutes, the Acura® *electro* switches automatically to an energy saving stand-by mode (display switches off) to guarantee a longer operation. Simply press start button to re-activate instrument.*

# PARAMETER SETTING

## Holding the electronic pipette (fig. 1)

The ergonomic shape of the Acura® *electro* allows long pipetting series without hand fatigue. Place finger rest on the phalanx of forefinger. The thumb reaches naturally start button (1) and ejector button (7), both easily activated. Multichannel casing revolves to allow the selection of the best working position.

## Left or right display reading















OPERATION	ACTION	KEY/BUTTON	LCD DISPLAY
<b>Configuration for left or right handed operation</b>	Press (> 0.5 sec.)		
	Validate function		
	Select		
	Validate side		
	Press (> 0.5 sec.) Back to current pipetting mode		

**Note:** After selection of left or right display reading, the last pipetting mode used will be displayed.

# PARAMETER SETTING

## Beeping sound

Beep sound on keys can be turned on/off anytime.









OPERATION	ACTION	KEY/BUTTON	LCD DISPLAY
Beeping sound configuration	Press (> 0.5 sec.)		
	Press		
	Press		
	Validate function		
	Select	 	
	Validate		
	Press (> 0.5 sec.) Back to current pipetting mode		

**Note:** Selecting the "off" mode will disable all warning sounds.

# PARAMETER SETTING

## Forward mode, programming and pipetting

In forward mode, the exact volume desired is aspirated. Liquid dispensing is automatically followed by a short excess plunger movement (blow out). Plunger returns back to its initial position one second later.

OPERATION	ACTION	KEY/BUTTON	LCD DISPLAY
<b>Forward pipetting</b>	Select mode		
	Validate mode		 <i>Last settings appear by default</i>
<b>Choice of volume</b>	Ex: select 400 $\mu$ L	 	
	Validate volume		

## Pipetting in forward mode

Press start button gently until first stop to work at the slow pipetting speed. Press fully (second stop) to work at the selected pipetting speed (fig. 2A).









OPERATION	ACTION	KEY/BUTTON	LCD DISPLAY
<b>Aspiration</b>	Press		
			
<b>Dispensing</b>	Press		
			

**Notes:** Plunger stays down when start button is kept pressed, and returns to initial position when released. Slightly touch reservoir wall when dispensing.

# PARAMETER SETTING









## Reverse mode, programming and pipetting

In reverse mode, the liquid is aspirated in excess of the selected volume. However, the set volume only will be delivered. The excess volume remains in the tip and can be kept or discarded. The reverse pipetting mode is recommended for viscous, volatile or foaming liquids.

OPERATION	ACTION	KEY/BUTTON	LCD DISPLAY
<b>Choice of reverse pipetting mode</b>	Select		
	Validate mode		 <i>Last settings appear by default</i>
<b>Choice of volume</b>	Ex: select 150 µL	 	
	Validate volume		

## Pipetting in reverse mode

Press start button gently until first stop to work at the slow pipetting speed. Press fully (second stop) to work at the selected pipetting speed (fig. 2A).

OPERATION	ACTION	KEY/BUTTON	LCD DISPLAY
<b>Aspiration</b>	Press		
			
<b>Dispensing</b>	Press		
<b>Excess volume</b>	Double click		
			

**Notes:** Skip “purge” by holding start button down after dosing is completed. The next sample is aspirated directly after release of the start button.  
Slightly touch reservoir wall when dispensing.

# PARAMETER SETTING

## Stepper mode, programming and pipetting

In stepper mode, the volume aspirated is in small excess of the sum of every single aliquot. It is distributed step by step according to volume and number of aliquots programmed by the user.

OPERATION	ACTION	KEY/BUTTON	LCD DISPLAY
<b>Choice of stepper pipetting mode</b>	Select		
	Validate mode		 <i>Last settings appear by default</i>
<b>Choice of volume</b>	Ex : select 50 µL	 	
	Validate volume		 <i>Display show maximal number of aliquots possible for the selected volume</i>
<b>Choice: number of aliquots</b>	Ex: select 15 x	 	
	Validate aliquots		

## Maximum number of aliquots

### Acura® electro 926 XS

Volume range µL	Maximum numbers of aliquots
0.1 – 2	20 x 0.1 µL
0.5 – 10 or 10Y	20 x 0.5 µL
1 – 20	20 x 1 µL
2.5 – 50	20 x 2.5 µL
5 – 100	20 x 5 µL
10 – 200	20 x 10 µL
50 – 1000	20 x 50 µL

### Acura® electro 956 (8 - 12 channels)

Volume range µL	Maximum numbers of aliquots
0.5 – 10	20 x 0.5 µL
2.5 – 50	20 x 2.5 µL
10 – 200	20 x 10 µL
20 – 350	18 x 20 µL

### Acura® electro 936

Volume range mL	Maximum numbers of aliquots
0.1 – 2	20 x 0.1 mL
0.25 – 5	20 x 0.25 mL
0.5 – 10	20 x 0.5 mL

# PARAMETER SETTING

## Pipetting in stepper mode

Press start button gently until first stop to work at the slow pipetting speed. Press fully (second stop) to work at selected pipetting speed (fig. 2A).







OPERATION	ACTION	KEY/BUTTON	LCD DISPLAY
<b>Aspiration</b> (Ex: 15 x 50 $\mu$ L)	Press		
	Ready		
<b>Dispensing</b>	Press		
			 <i>Number of aliquots decrease after each dispensing</i>
<b>Dispensing</b>	Press		 
<b>Excess volume</b>	see next page		

**Note:** Slightly touch reservoir wall when dispensing.



# PARAMETER SETTING

## Stepper mode, excess volume control

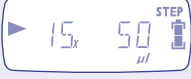
OPERATION	ACTION	KEY/BUTTON	LCD DISPLAY
Current display			
Keep excess volume, ex. aspiration of same liquid	Press		
			
<i>or</i>			
Blow out excess volume	Double click		
Ready for aspiration of new liquid			





















## Stepper mode, interruption of pipetting sequence

OPERATION	ACTION	KEY/BUTTON	LCD DISPLAY
Current display			
End of pipetting	Press		
Blow out residual volume	Double click		
Ready for new filling			

# PARAMETER SETTING

## Dilution mode, programming and pipetting

In dilution mode, up to 3 volumes of different liquids (each separated by an air bubble) will be aspirated. The total resulting volume is then dispensed in a single dose.



















OPERATION	ACTION	KEY/BUTTON	LCD DISPLAY
<b>Choice of dilution pipetting mode</b>	Select		
	Validate mode		
<b>Choice of 1st volume</b>	Ex: select 250 μL	 	
	Validate volume 1		
<b>Choice of 2nd volume</b>	Ex: select 100 μL	 	
	Validate volume 2		
<b>Choice of 3rd volume (optional)</b>	Ex : select 50 μL	 	
<b>No 3rd volume?</b>	Select 0 μL		
	Validate volume 3		

**Note:** Air bubbles in macrotips (Acura® electro 936 models) only serve the purpose of separating liquid at the lower tip area.

# PARAMETER SETTING

## Pipetting in dilution mode

Press start button gently until first stop to work at the slow pipetting speed. Press fully (second stop) to work at the selected pipetting speed (fig. 2A).

OPERATION	ACTION	KEY/BUTTON	LCD DISPLAY
<b>Aspiration 1st volume</b>	Press		 
<b>Aspiration air bubble</b>	Lift tip out of the liquid, Press		 
<b>Aspiration 2nd volume</b>	Press		 
<b>Aspiration air bubble</b>	Lift tip out of the liquid, Press		 
<b>Aspiration 3rd volume (if programmed)</b>	Press		 
<b>Dispensing V1+V2+V3</b>	Press		
<b>Ready for new filling</b>			

**Note:** Slightly touch reservoir wall when dispensing.

# PARAMETER SETTING









## Dilution mode, interruption of pipetting sequence

OPERATION	ACTION	KEY/BUTTON	LCD DISPLAY
Current display			
End of pipetting	Press		
Blow out residual volume	Double click		
Ready for new filling			

# PARAMETER SETTING

## Tactile mode, programming

In tactile mode, aspiration or pipetting is activated when start button is pressed. The process stops when button is released. It starts again by pressing start button. This mode is useful for liquid measurement/titration or gel loading.

OPERATION	ACTION	KEY/BUTTON	LCD DISPLAY
<b>Choice of tactile pipetting mode</b>	Select		
	Validate mode		 <i>Last settings appear by default</i>
<b>Choice of maximum volume</b>	Ex: select 400 µL	 	
	Validate volume		

## Tactile mode, pipetting – Measurement of unknown volume

Press start button gently until first stop to aspire liquid. Release button to stop aspiration. Press again to continue aspiration.

OPERATION	ACTION	KEY/BUTTON	LCD DISPLAY
<b>Aspiration of unknown volume</b>	Press until 1 <sup>st</sup> stop and maintain		 <i>Display from 0 to 400 Release button = stop Press until 1<sup>st</sup> stop = continue aspiration</i>
<b>Dispensing</b>	Press	 	
	Press until 2 <sup>nd</sup> stop		
<b>Ready for new filling</b>			

# PARAMETER SETTING





## Tactile mode, pipetting – Titration or gel loading

Press start button until second stop to aspire set volume. Press gently button until stop for dispensing. Release button to stop dispensing, or press again to continue distribution.

OPERATION	ACTION	KEY/BUTTON	LCD DISPLAY
<b>Aspiration set volume</b>	Press until 2 <sup>nd</sup> stop		
			
<b>Dispensing</b>	Press until 1st stop and maintain		 <p>Display from 400 to 0 Release button = stop Press until 1<sup>st</sup> stop = continue dispensing</p>
<b>End of dispensing</b>	Press		
<b>Blow out residual volume</b>	Double click		
<b>Ready for new filling</b>			

*Note: Slightly touch reservoir wall when dispensing.*

## Tactile mode interruption of pipetting sequence

OPERATION	ACTION	KEY/BUTTON	LCD DISPLAY
<b>End of work</b>	Press		
<b>Blow out residual volume</b>	Double click		
<b>Ready for new filling</b>			

# PARAMETER SETTING

## Mixing

Available in any pipetting modes (except tactile mode), the mixing performs consecutive back and forth aspiration/dispensing of the set volume. It is only possible after pipetting or purge steps are over.

OPERATION	ACTION	KEY/BUTTON	LCD DISPLAY
<b>Mixing with 3 cycles of aspiration/dispensing</b>	Press 1 x	 MIXING	
<b>or</b>			
<b>Continuous mixing</b>	Keep key pressed	 MIXING	
<b>Back to pipetting</b>	Release key		 <i>Last settings appear by default</i>

## Pipetting cycle counter

Counter displays number of cycles performed since last zeroing. Consecutive aspiration and dispensing are counted as one cycle.

OPERATION	ACTION	KEY/BUTTON	LCD DISPLAY
<b>Display cycle counter</b>	Press 2 x	 COUNT	
<b>Reset counter</b>	Press (> 1 sec.)	 COUNT	
<b>Back to pipetting</b>	Release key		 <i>Last settings appear by default</i>





# OPERATION

## Selection of pipetting speed (fig. 2B)

Three pipetting speeds are available. Simply move the selector from left to right (slow/fast) to adapt working speed to the type of liquid or to a specific application. Independently from the speed selection, it is always possible to aspirate or distribute at the slow speed by gently pressing start button half way (feel first stop). Pipetting speed can not be modified when working with tactile mode.

## Charge level of power handle (fig. 3)

Pay attention to battery indicator on LCD to avoid unexpected power cut-off. For appropriate handling of the power handle, refer to chapters on “Replacing power handle” (fig. 4B) and “Charging power handle” (fig. 5 and 6) for more details.

LCD DISPLAY	SIGNIFICATION/CAUSE	SOLUTION
	Battery fully charged	
	Battery partially charged	
	Low battery	It is recommended to charge battery after pipetting work is finished or to replace power handle
	Battery almost empty	Energy level insufficient Instrument will switch off Replace or charge power handle immediately

**Note:** Always keep one or more spare power handle(s) available on the charging stand.



# OPERATION

## Changing volumetric module

Lower assembly of the Acura® *electro* is interchangeable on a single control unit (upper assembly). Pipetting sequence must be completed before disassembling.

### Disassembling volumetric module up 2 mL (fig. 9 and 9a inside front cover)

- ① Press ejector button to the bottom
- ② Hold screw of tip ejector and slightly turn to the left. Pull out tip ejector (see arrows on handle).
- ③ Unscrew barrel
- ④ Unclip plunger

Before storing volumetric module, reassemble plunger, barrel, and ejector and place protection cap (accessory, Cat. No. 825.691) on the top.

### Disassembling macro volumetric module 5 mL to 10 mL (fig. 10 inside front cover)

- ① Slightly turn ejector nut to unclip from ejector cap
- ② Unscrew barrel, then gently pull barrel to unclip plunger rod
- ③ Press ejector button to the bottom
- ④ Turn ejector cap to the left and pull out

Before storing volumetric module, reassemble ejector nut and cap then place protection cap (accessory, Cat. No. 825.691) on the top.

### Assembling

- Remove protection cap and pull out plunger
- ⑤ Hold plunger between thumb and index finger and clip plunger

**Note:** *Plunger must be clicked in the control unit before assembling the module.*

- ③ Screw on barrel
- ① Press ejector button to the bottom
- ② Introduce ejector screw into the control unit (see arrows on handle). Slightly turn right to lock. Release ejector button

Enter module data in control unit prior to use, as described in chapter “Programming volumetric module”.

### Assembling

- Remove protection cap
- ⑤ Pull out plunger rod and introduce tip or rod in side hole to prevent from retracting
  - ⑥ Introduce plunger rod in control unit and click in

**Note:** *Plunger must be clicked in the control unit before assembling the module. If difficulty to pull out plunger, use the small pin supplied in the box when ordering additional volumetric module.*

Hold pipette nozzle and screw barrel firmly

- ③ Press ejector button, introduce tooth of ejector cap in recess (see arrows on handle), and turn right to lock

Enter module data in control unit prior to use as described in chapter “Programming volumetric module”.

**Notes:** Power handle **must** be connected on control unit prior to re-assembling volumetric module. Watch for not activating programming keys when changing volumetric module.

**Important:** Before the very first use of a new volumetric module, perform pipette calibration according to chapter “Calibration”.

## Changing volumetric module *(continued)*

### Disassembling multichannel volumetric module (fig. 12 inside front cover)

- ① Press ejector button
- ② Turn ejector nut to the left till its lowest position, unclip ejector ring and release ejector button
- ③ Hold volumetric module firmly with one hand and, while pulling down casing, rotate slowly to unscrew
- ④ Gently unclip plunger rod.

Before storing volumetric module, place protection cap (accessory, Cat. No. 825.691) on the top.

### Assembling

Remove protection cap

- ⑤ Pull out plunger rod and introduce small pin (i.e. paper clip) in side hole to prevent from retracting
- ⑥ Introduce plunger rod in control unit and click in

**Note:** *Plunger must be clicked in the control unit before assembling the module.*

Hold casing with fingers pulling against barrel extremities

- ⑦ Slowly screw volumetric module while positioning tooth of ejector ring in recess (see arrows on handle)
- ⑧ Press ejector button, turn ejector ring to the right until tooth clicks in and release ejector button

Control proper functioning of ejector button. Set ejector height to desired position. Enter module data in control unit prior to use as described in chapter "Programming volumetric module".





**Notes:** *Power handle **must** be connected on control unit prior to re-assembling volumetric module. Watch for not activating programming keys when changing volumetric module.*

**Important:** *Before the very first use of a new volumetric module, perform pipette calibration according to chapter "Calibration".*

# OPERATION

## Programming of volumetric module

When new volumetric module is inserted in control unit, user **must** enter corresponding parameters prior to start working.

OPERATION	ACTION	KEY/BUTTON	LCD DISPLAY
Choice of volumetric module			
			<i>Last settings appear by default</i>
	Ex: module ranging 20-200 $\mu$ L	 	
	Validate the choice		
			<i>Instrument performs a self-control test automatically</i>











Select pipetting mode according to chapter “Parameter setting”



*Note: "X" stands for reduced length volumetric module.*



## Correction of volumetric module selection

It is also possible to access the menu “Programming of volumetric module” at anytime.

OPERATION	ACTION	KEY/BUTTON	LCD DISPLAY
Current display			
Access volumetric module menu	Press (> 0.5 sec.)		
	Press		
	Validate		
Correction of volumetric module selection	Ex: 8-channel module ranging 5-50 $\mu$ L	 	

# OPERATION

## Correction of volumetric module selection (continued)

OPERATION	ACTION	KEY/BUTTON	LCD DISPLAY
Correction of volumetric module (continued)			 <i>Instrument performs self-control test automatically</i>
Select pipetting mode according to chapter “Programming”			

**Warning:** The programmed volumetric module must correspond to the one fitted on the pipette assembly.

## Use of Pasteur pipette (Acura 936, 2 mL and 5 mL)

Glass Pasteur pipettes are of advantage in handling PP affecting solvents. Optional adapter-nozzles fit macro models to accommodate standard 2 mL Pasteur pipettes (ext. Ø 6.5-7.2 mm) in addition to Polypropylene tips.

Model 936 – 2 mL Cat. No. 1.835.631

Model 936 – 5 mL Cat. No. 1.836.633

Slightly grease O-rings in adapter for tight Pasteur pipette fitting.

**Warning:** Do not set volume higher than 2 mL.

## Adjustment of tip ejector (fig. 14 and 15)

The Justip™ system allows instant height adjustment (+/- 2 mm) of ejector for best fitting of the tip used (optimal distance).

Set the correct position (~0.5 mm space between tip and ejector) by rotating ejector screw to the left or to the right (LO-HI). Click stops prevent any unwanted change while pipetting.

**Note:** Ejector head on multichannel models designed for soft, sequential tip removal.

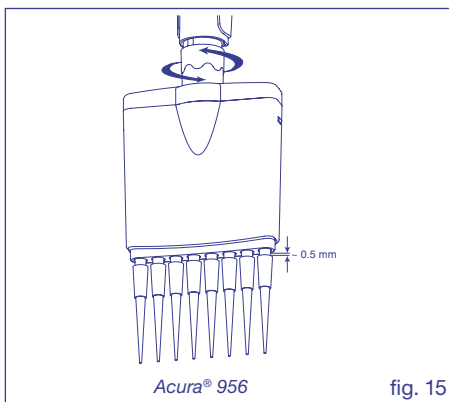
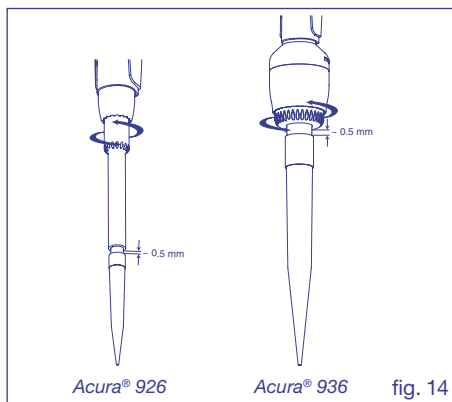



# MAINTENANCE AND STERILISATION

The Acura® *electro* requires little maintenance. To obtain long term trouble free use, special attention during pipetting and regular cleaning are recommended.

## Cleaning

- External parts of control unit, power handle and charging stands are cleaned with dampened cloth
- Volumetric module, once disassembled according to instructions in chapter “Operation”, can be cleaned, or soaked in appropriate decontamination or disinfecting solutions. Ultra-sonic bath helps to remove sticking residues
- On volumetric modules up to 1000  $\mu\text{L}$ , plunger tightness is provided by PTFE sleeve on O-ring or with a lip seal. Grease slightly lip seal or O-ring and sleeve. Also grease plunger, O-ring and barrel wall of macro models before reassembling
- Any defective part must be replaced. Order original spare parts from authorised dealers

*Warning:* No liquid must penetrate into control unit (upper assembly).

## Replacement of tightness parts (models 926 XS, 936 and 956)

### PTFE sleeve, single channel micro-volumetric modules up to 20 $\mu\text{L}$

- Tightness parts are not accessible on 2, 10, 10Y and 20  $\mu\text{L}$  models. In case of tightness problem, the whole barrel must be changed. Do not force the plunger into the barrel.
- Remove volumetric module from control unit according to instructions in chapter “Operation” (fig. 9)

### O-ring and PTFE sleeve, single channel micro-volumetric modules (50 $\mu\text{L}$ and 100 $\mu\text{L}$ )

- To guarantee tightness, minimum friction and spare parts compatibility, the PTFE sleeve can not be changed by itself. Changing the barrel assembly, including plunger is necessary.
- Remove volumetric module from control unit according to instructions in chapter “Operation” (fig. 9)

### Lip seal single channel micro-volumetric modules (200 $\mu\text{L}$ and 1000 $\mu\text{L}$ )

- Remove volumetric module from control unit according to instructions in chapter “Operation” (fig. 9a and 9b)
- Lift both clips of the cylinder head
- Remove the cylinder head
- Gently remove the lip seal with fingers or with a tip.
- Clean the plunger and apply thin layer of grease
- Slightly grease the lip seal on the external diameter and between the lips
- Reposition the lip seal inside the cylinder and clip cylinder head
- Reassemble according to instructions in chapter “Operation”

### O-ring, single channel macro-volumetric modules

- Remove volumetric module from control unit according to instructions in chapter “Operation” (fig. 9a and 10)
- Press both barrel clips with fingers to separate from bonnet for 5 mL and 10 mL modules (fig. 11)
- Pull out plunger assembly. Unscrew plunger rod and remove washers and spring
- Change parts if needed. Grease O-ring, washer and barrel
- Reassemble plunger assembly, barrel and bonnet according to instructions in chapter “Operation”

*Note:* Plunger must be “clicked” with the control unit **before** assembling the volumetric volume.

# MAINTENANCE AND STERILISATION

## Replacement of tightness parts *(continued)*

### Barrel change, multichannel volumetric modules

**Note:** *Tightness O-ring cannot be removed from barrel. Change barrel if tightness is deficient.*

- Remove volumetric module from control unit according to instructions in chapter «Operation» (fig. 12)
- Press both clips of cover with pointed tool and remove casing (fig. 13)
- Press bottom clips (a) of barrel holder and separate (b)
- Pull out barrels (c)
- Apply thin, even grease layer on all surface length of plunger before reassembling
- Introduce barrel on plunger. Separate both plate of barrel holder, reposition barrel
- Clip barrel plate, all barrels must be sitting properly and aligned
- Place assembly in casing and clip on cover

**Notes:** *Plunger must be "clicked" with the control unit **before** assembling the volumetric volume.*

*Markings on casing (volume) and on cover (Justip) should appear on opposite sides.*

*Nozzle barrel O-rings on 200 µL module can be changed if needed (ref. 855.945)*

## Sterilisation

Only the volumetric module (lower part) is autoclavable at 121°C (20 minutes, 1 atm). Disassemble from control unit according to instructions in chapter "Operation". Before autoclaving, remove nozzle filter on 936 models. Autoclave volumetric module as one assembly. Parts must be cooled down and completely dry before mounting on control unit. Check tightness and accuracy after first cycle, then regularly but at least after 50 autoclaving cycles. Correct autoclaving and resulting sterility are the responsibility of the user.

**Note:** *Setting parameters on the Acura® electro must correspond to those of the assembled volumetric module.*

# INSTRUMENT CALIBRATION

Each Acura® *electro* pipette is factory tested for conformity according to ISO 8655 standards. Calibration parameters are permanently memorised in the instrument's microprocessor. If performance results are no longer within recommended values, for instance after QC check, or replacing parts, or if changes occur in physical parameters (liquid density, temperature, atmospheric pressure), re-calibration is easily performed through the calibration menu.

Factory calibration done in forward mode. Calibration can be performed in forward, reverse, step or dilution modes but not in tactile mode.

**Warning:** A calibration is necessary before the very first use of a volumetric module other than the one supplied with the instrument (even if same range).

*It is recommended to control instrument performance in accordance with internal laboratory procedures (SOP/GLP, etc.) or at least once a year.*

## Calibration increments

In the calibration menu, "QC-CAL" is the original calibration value of a factory-calibrated instrument. Other volumetric modules purchased as accessories will display "0" as target calibration value. Calibration is performed by changing the calibration unit figure according to following values:

Volumetric module (lower assembly)	2 µL	10 µL	20 µL	50 µL	100 µL	200 µL	350 µL
Calibration increment	± 0.0005 µL	± 0.0025 µL	± 0.005 µL	± 0.0125 µL	± 0.025 µL	± 0.05 µL	± 0.1 µL
Volumetric module (lower assembly)	1000 µL	2 mL	5 mL	10 mL			
Calibration increment	± 0.25 µL	± 0.5 µL	± 1.25 µL	± 2.5 µL			

## Calibration procedure

User can perform a 2-point ( $V_{min}$  and  $V_{max}$ ) or 3-point ( $V_{min}$ ,  $V_{mid}$  and  $V_{max}$ ) calibration. See graphs below:

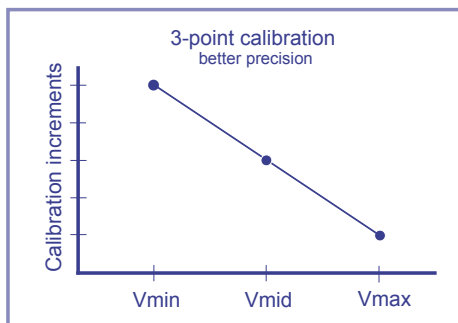
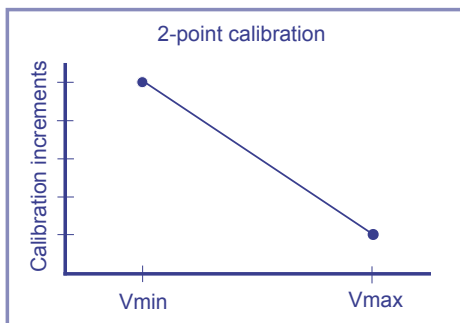



# INSTRUMENT CALIBRATION

## New calibration

When performance results are no longer within recommended values, a calibration should be performed using an analytical balance after insuring perfect working condition of the instrument. Proceed as follow for **each** calibration point.





OPERATION	ACTION	KEY/BUTTON	LCD DISPLAY
<b>Finish pipetting sequence</b>	Be sure desired mode is set before proceeding		
<b>Access calibration menu</b>	Press first (> 0.5 sec.)		
	Then press simultaneously		
	Validate		
<b>Select calibration point</b>	Press	 	 
	Validate		
	<p><i>Display shows "QC-CAL" for a factory-calibrated instrument where the original parameters have not been modified. If modified, display shows the number of calibration increments previously selected</i></p>		

<b>Change calibration parameter</b>	Ex: volume reduction of 0.75 µL (= 3 x 0.25 µL / increment) on a 1000 µL model	 	
	Press		
	Validate		

**Note:** When purchasing a new volumetric module as an accessory, it is important to introduce calibration parameters before very first use. To do so, perform calibration according to chapter "Calibration" procedure. The values entered are automatically memorised for each volumetric modules and modes.

# TROUBLE SHOOTING

## Error messages



LCD DISPLAY	CAUSE	SOLUTION
	Plunger sticking or dragging	Disassemble volumetric module according to chapter "Operation" Clean plunger according to chapter "Maintenance" Reset instrument (see below)
	Plunger rod not clipped before assembling	Reconnect plunger rod according step 5 and 6 of page 21 and 22. Reset instrument (see below) Contact authorised dealer for control if error persists
	Microprocessor detected deviation between set volume and effective plunger travel	Reset instrument (see below) Contact authorised dealer if error become frequent
	Plunger rod not clipped before assembling	Reconnect plunger rod according step 5 and 6 of page 21 and 22. Reset instrument (see below)
	Volumetric module disassembled when pipetting sequence is not completed	Reset instrument (see below) Confirm selection of volumetric module after re-assembling
	Only in <b>dilution mode</b> Volumes programmed larger than maximal aspiration capacity	Reset instrument (see below)

## Instrument reset

OPERATION	ACTION	KEY/BUTTON	LCD DISPLAY
Error message			
	Press		
Reset	Double click on start button		
Error message	Only in dilution mode		
	Press		
Select new volume	Press	 	

# TROUBLE SHOOTING

## Instrument reset *(continued)*

OPERATION	ACTION	KEY/BUTTON	LCD DISPLAY
Or change calibration settings	Press then		
<i>Refer to chapter "Calibration" for new setting</i>			

## Other failures

Observation	Possible cause	Action
Power handle does not fit pipette control unit	Control if compatible 4.8V power handle	Exchange with 4.8V power handle
Power handle or instrument is not charging/no red light	Control if compatible 4.8V device	Exchange with 4.8V compatible device
Red light on charger stand not lid	Micropipette or power handle not sitting correctly on stand	Reposition instrument or power handle
Plug do not fit into stand	Control for correct power supply model 4.8V	Use 4.8V power supply
No display	Instrument in stand-by	Press start button to activate instrument
	Battery is discharged	Charge power handle or replace if damaged
LCD display on but no reaction when pressing start button	Volumetric module not correctly locked	Check volumetric module
Poor instrument performance	Lack of tightness	Check proper tip fitting. Use tips compatible with the instrument Check tip cone, change if damaged Check O-ring PTFE sleeve, and lipseal change if damaged
	Instrument not calibrated	Perform new calibration
	Instrument pipetting viscous, or volatile solutions, liquid temperature not comprised between 20-25°C	New calibration with specific solution or temperature
Reduced battery life span	Power handle damaged	Replace power handle
	Too much friction in lower assembly	Clean lower assembly
Wrong distributed volume	Erroneous programming of volumetric module	Set parameters correctly
Long pipetting time Plunger moves erratically	Plunger sticking or dragging	Disassemble volumetric module, clean, apply, apply thin layer of grease on plunger
	Motor drive blocked	Contact authorized dealer for control

# PERFORMANCE

Performance values obtained in Forward pipetting mode with bi-dist. water at constant temperature ( $\pm 0.5^\circ\text{C}$ ) between 20 and 25°C according to ISO 8655.

## Acura® electro 926 XS (reduced length)

Volume $\mu\text{L}$	Division $\mu\text{L}$	Inaccuracy (E%)			Imprecision (CV%)			Tip style
		Min. vol.	Mid vol.	Max. vol.	Min. vol.	Mid vol.	Max. vol.	
0.1 – 2	0.01	<+/- 2.5 % <sup>1</sup>	<+/- 1.2 %	<+/- 0.9 %	< 2.5 % <sup>1</sup>	< 1.5 %	< 0.8 %	Ultra 10 $\mu\text{L}$
0.5 – 10	0.05	<+/- 1.2 % <sup>2</sup>	<+/- 0.8 %	<+/- 0.6 %	< 1.5 % <sup>2</sup>	< 0.7 %	< 0.35 %	Ultra 10 $\mu\text{L}$
0.5 – 10 Y	0.05	<+/- 1.2 % <sup>2</sup>	<+/- 0.8 %	<+/- 0.6 %	< 1.7 % <sup>2</sup>	< 0.8 %	< 0.4 %	200 $\mu\text{L}$
1 – 20	0.1	<+/- 1.2 % <sup>2</sup>	<+/- 0.6 %	<+/- 0.5 %	< 1.2 % <sup>2</sup>	< 0.4 %	< 0.3 %	200 $\mu\text{L}$
2.5 – 50	0.25	<+/- 1.0 % <sup>2</sup>	<+/- 0.6 %	<+/- 0.5 %	< 0.7 % <sup>2</sup>	< 0.3 %	< 0.25 %	200 $\mu\text{L}$
5 – 100	0.5	<+/- 1.0 % <sup>2</sup>	<+/- 0.6 %	<+/- 0.5 %	< 0.7 % <sup>2</sup>	< 0.3 %	< 0.2 %	200 $\mu\text{L}$
10 – 200	1.0	<+/- 1.0 % <sup>2</sup>	<+/- 0.6 %	<+/- 0.4 %	< 0.6 % <sup>2</sup>	< 0.2 %	< 0.15 %	200 $\mu\text{L}$
50 – 1000	5.0	<+/- 0.8 % <sup>2</sup>	<+/- 0.5 %	<+/- 0.4 %	< 0.4 % <sup>2</sup>	< 0.15 %	< 0.1 %	1000 $\mu\text{L}$

## Acura® electro 936

Volume mL	Division mL	Inaccuracy (E%)			Imprecision (CV%)			Tip style
		Min. vol.	Mid vol.	Max. vol.	Min. vol.	Mid vol.	Max. vol.	
0.1 – 2	0.01	<+/- 1.5 % <sup>2</sup>	<+/- 1.0 %	<+/- 0.5 %	< 0.6 % <sup>2</sup>	< 0.3 %	< 0.15 %	2 mL
0.25 – 5	0.05	<+/- 1.2 % <sup>2</sup>	<+/- 0.8 %	<+/- 0.5 %	< 0.6 % <sup>2</sup>	< 0.3 %	< 0.15 %	5 mL
0.5 – 10	0.05	<+/- 1.0 % <sup>2</sup>	<+/- 0.7 %	<+/- 0.5 %	< 0.5 % <sup>2</sup>	< 0.2 %	< 0.15 %	10 mL

Measurements done with nozzle protection filters.

## Acura® electro 956 – 8 channels

Volume $\mu\text{L}$	Division $\mu\text{L}$	Inaccuracy (E%)			Imprecision (CV%)			Tip style
		Min. vol.	Mid vol.	Max. vol.	Min. vol.	Mid vol.	Max. vol.	
0.5 – 10	0.05	<+/- 3.5 % <sup>2</sup>	<+/- 1.5 %	<+/- 1.0 %	< 3.0 % <sup>2</sup>	< 0.9 %	< 0.7 %	Ultra 10 $\mu\text{L}$
2.5 – 50	0.25	<+/- 1.0 % <sup>2</sup>	<+/- 0.9 %	<+/- 0.8 %	< 1.0 % <sup>2</sup>	< 0.6 %	< 0.4 %	200 $\mu\text{L}$
10 – 200	1.0	<+/- 0.9 % <sup>2</sup>	<+/- 0.7 %	<+/- 0.6 %	< 0.6 % <sup>2</sup>	< 0.4 %	< 0.25 %	200 $\mu\text{L}$
20 – 350	5.0	<+/- 1.0 % <sup>2</sup>	<+/- 0.8 %	<+/- 0.6 %	< 0.6 % <sup>2</sup>	< 0.4 %	< 0.25 %	350 $\mu\text{L}$

## Acura® electro 956 – 12 channels

Volume $\mu\text{L}$	Division $\mu\text{L}$	Inaccuracy (E%)			Imprecision (CV%)			Tip style
		Min. vol.	Mid vol.	Max. vol.	Min. vol.	Mid vol.	Max. vol.	
0.5 – 10	0.05	<+/- 3.5 % <sup>2</sup>	<+/- 1.5 %	<+/- 1.0 %	< 3.0 % <sup>2</sup>	< 0.9 %	< 0.7 %	Ultra 10 $\mu\text{L}$
2.5 – 50	0.25	<+/- 1.0 % <sup>2</sup>	<+/- 0.9 %	<+/- 0.8 %	< 1.0 % <sup>2</sup>	< 0.6 %	< 0.4 %	200 $\mu\text{L}$
10 – 200	1.0	<+/- 0.9 % <sup>2</sup>	<+/- 0.7 %	<+/- 0.6 %	< 0.6 % <sup>2</sup>	< 0.4 %	< 0.25 %	200 $\mu\text{L}$
20 – 350	5.0	<+/- 1.0 % <sup>2</sup>	<+/- 0.8 %	<+/- 0.6 %	< 0.6 % <sup>2</sup>	< 0.4 %	< 0.25 %	350 $\mu\text{L}$

Performance measured at <sup>1</sup> 0.5  $\mu\text{L}$ , <sup>2</sup> 10% of nominal value.

**Notes:** Use of other tips than those recommended, as well as pipetting viscous or volatile liquids may lead to performance deviation compared to those shown in the above figure. Product specifications subject to change without prior notice.

Performance value obtained in Forward mode. Small deviations may exist when using other pipetting modes. To obtain best possible performance with one specific pipetting mode, it is recommended to perform a new calibration.

## PERFORMANCE

Performance values obtained in Forward pipetting mode with bi-dist. water at constant temperature ( $\pm 0.5^\circ\text{C}$ ) between 20 and 25°C according to ISO 8655.

### Acura® *electro* 926 (regular length)

Volume Division		Inaccuracy (E%)			Imprecision (CV%)			Tip style	Volumetric module
$\mu\text{L}$	$\mu\text{L}$	Min. vol.	Mid vol.	Max. vol.	Min. vol.	Mid vol.	Max. vol.		
0.1 – 2	0.01	<+/- 3.0 % <sup>1</sup>	<+/- 1.8 %	<+/- 1.5 %	< 3.0 % <sup>1</sup>	< 1.6 %	< 0.9 %	Ultra 10 $\mu\text{L}$	800.0002
0.5 – 10	0.05	<+/- 2.2 % <sup>2</sup>	<+/- 1.1 %	<+/- 0.9 %	< 1.7 % <sup>2</sup>	< 0.8 %	< 0.4 %	Ultra 10 $\mu\text{L}$	800.0010
0.5 – 10 Y	0.05	<+/- 2.2 % <sup>2</sup>	<+/- 1.1 %	<+/- 0.9 %	< 2.0 % <sup>2</sup>	< 1.0 %	< 0.6 %	200 $\mu\text{L}$	800.0010Y
1 – 20	0.1	<+/- 2.0 % <sup>2</sup>	<+/- 1.0 %	<+/- 0.8 %	< 1.5 % <sup>2</sup>	< 0.5 %	< 0.4 %	200 $\mu\text{L}$	800.0020
2.5 – 50	0.25	<+/- 1.5 % <sup>2</sup>	<+/- 0.8 %	<+/- 0.6 %	< 1.0 % <sup>2</sup>	< 0.4 %	< 0.3 %	200 $\mu\text{L}$	800.0050
5 – 100	0.5	<+/- 1.5 % <sup>2</sup>	<+/- 0.8 %	<+/- 0.6 %	< 1.0 % <sup>2</sup>	< 0.35 %	< 0.25 %	200 $\mu\text{L}$	800.0100
10 – 200	1.0	<+/- 1.5 % <sup>2</sup>	<+/- 0.8 %	<+/- 0.5 %	< 0.7 % <sup>2</sup>	< 0.3 %	< 0.2 %	200 $\mu\text{L}$	800.0200
50 – 1000	5.0	<+/- 1.5 % <sup>2</sup>	<+/- 0.7 %	<+/- 0.5 %	< 0.5 % <sup>2</sup>	< 0.25 %	< 0.15 %	1000 $\mu\text{L}$	800.1000

Performance measured at <sup>1</sup> 0.5 $\mu\text{L}$ , <sup>2</sup> 10% of nominal volume.

**Notes:** Use of other tips than those recommended, as well as pipetting viscous or volatile liquids may lead to performance deviation compared to those shown in the above figure. Product specifications subject to change without prior notice.

Performance value obtained in Forward mode. Small deviations may exist when using other pipetting modes. To obtain best possible performance with one specific pipetting mode, it is recommended to perform a new calibration.

# WARRANTY

Your Acura® *electro* and power handle are guaranteed against any material or manufacturing defects for the period of time specified in its QC certificate. Damages due to non-respect of manufacturer's instructions, safety precautions or autoclaving conditions, as well as material colour alteration are excluded from the warranty. Repair and replacement of parts do not extend warranty time. Claims for warranty are void if instrument has been tempered. Should regular maintenance not eliminate a detected defect, return the instrument to the dealer from whom it was purchased after obtaining return authorisation.

*Note: Decontaminate volumetric module of the instrument prior to returning it.*





# ORDERING INFORMATION

## Micropipettes

Initial package includes electronic pipette, individual QC certificate, two power handles, charging stand, power supply, accessories and operating instructions.

Pipette alone is supplied with individual QC certificate, power handle, Qualitips® pipette tips samples and operating instructions.

### Acura® *electro* 926 XS (reduced length)

Volume µL	Division µL	Tip style	Initial package* Cat. No.	Pipette alone Cat. No.
0.1 – 2	0.01	Ultra 10 µL	926.0002E	926.0002
0.5 – 10	0.05	Ultra 10 µL	926.0010E	926.0010
0.5 – 10Y	0.05	200 µL	926.002010YE	926.0010Y
1 – 20	0.1	200 µL	926.0020E	926.0020
2.5 – 50	0.25	200 µL	926.0050E	926.0050
5 – 100	0.5	200 µL	926.0100E	926.0100
10 – 200	1.0	200 µL	926.0200E	926.0200
50 – 1000	5.0	1000 µL	926.1000E	926.1000

### Acura® *electro* 936

Volume mL	Division mL	Tip style	Initial package* Cat. No.	Pipette alone Cat. No.
0.1 – 2	0.01	2 mL	936.02E	936.02
0.25 – 5	0.025	5 mL	936.05E	936.05
0.5 – 10	0.05	10 mL	936.10E	936.10

### Acura® *electro* 956 – 8 channels

Volume µL	Division µL	Tip style	Initial package* Cat. No.	Pipette alone Cat. No.
0.5 – 10	0.05	Ultra 10 µL	956.08.010E	956.08.010
2.5 – 50	0.25	200 µL	956.08.050E	956.08.050
10 – 200	1.0	200 µL	956.08.200E	956.08.200
20 - 350	5.0	350 µL	956.08.350E	956.08.350

### Acura® *electro* 956 – 12 channels

Volume µL	Division µL	Tip style	Initial package* Cat. No.	Pipette alone Cat. No.
0.5 – 10	0.05	Ultra 10 µL	956.12.010E	956.12.010
2.5 – 50	0.25	200 µL	956.12.050E	956.12.050
10 – 200	1.0	200 µL	956.12.200E	956.12.200
20 - 350	5.0	350 µL	956.12.350E	956.12.350

\* Replace E by country code if other plug type than Europe style needed: G = UK, U = USA-Japan, A = Australia-NZ



# ORDERING INFORMATION

## Volumetric module – all models

Volumetric module	Volume	Tip style	Cat. No.
Reduced length	0.1 – 2 µL	Ultra 10 µL	800.0002XS
	0.5 – 10 µL	Ultra 10 µL	800.0010XS
	0.5 – 10 µL	200 µL	800.0010YXS
	1 – 20 µL	200 µL	800.0020XS
	2.5 – 50 µL	200 µL	800.0050XS
	5 – 100 µL	200 µL	800.0100XS
	10 – 200 µL	200 µL	800.0200XS
Regular length	50 – 1000 µL	1000 µL	800.1000XS
	0.1 – 2 µL	Ultra 10 µL	800.0002
	0.5 – 10 µL	Ultra 10 µL	800.0010
	0.5 – 10 µL	200 µL	800.0010Y
	1 – 20 µL	200 µL	800.0020
	2.5 – 50 µL	200 µL	800.0050
	5 – 100 µL	200 µL	800.0100
	10 – 200 µL	200 µL	800.0200
	50 – 1000 µL	1000 µL	800.1000

Volumetric module	Volume	Tip style	Cat. No.
Macro	0.1 - 2 mL	2 mL	800.2000
	0.25 - 5 mL	5 mL	800.5000
	0.5 - 10 mL	10 mL	800.10000

8-channel	0.5 - 10 µL	Ultra 10 µL	800.08.010
	2.5 - 50 µL	200 µL	800.08.050
	10 - 200 µL	200 µL	800.08.200
	20 - 350 µL	350 µL	800.08.350
12-channel	0.5 - 10 µL	Ultra 10 µL	800.12.010
	2.5 - 50 µL	200 µL	800.12.050
	10 - 200 µL	200 µL	800.12.200
	20 - 350 µL	350 µL	800.12.350

## Accessories and charging stands

Description	Packaging	Cat. No.
Power handle, blue color, NiMH 4.8V	1 / pk	900.920.48
Power handle, blue color, NiMH 4.8V	2 / pk	900.922.48
Charging stand 3 positions for pipettes or power handles	1 / pk	320.903.48
Charging rack for power handles only (3 positions)	1 / pk	320.913.48
Power supply 100-240 V - Europe style plug	1 / pk	900.901.48E
Power supply 100-240 V - UK style plug	1 / pk	900.901.48G
Power supply 100-240 V - USA/Japan style plug	1 / pk	900.901.48U
Power supply 100-240 V - Australia/NZ style plug	1 / pk	900.901.48A
Nozzle protection filters for 2mL and 5mL models	250 / pk	322.05
Nozzle protection filters for 10mL model	100 / pk	322.10
Pasteur pipette adapter nozzle for 2mL model	1 / pk	1.835.631
Pasteur pipette adapter nozzle for 5mL model	1 / pk	1.835.633

# ORDERING INFORMATION

## Qualitips® pipette tips

Qualitips® compatibility chart	Acura® electro														
	926 XS and 800 module							936			956				
	0.1 - 2 µL	0.5 - 10 µL	0.5 - 10 µL (Y)	1 - 20 µL	2.5 - 50 µL	5 - 100 µL	100 - 200 µL	50 - 1000 µL	0.1 - 2 mL	0.25 - 5 mL	0.5 - 10 mL	0.5 - 10 µL	2.5 - 50 µL	10 - 200 µL	20 - 350 µL
<b>microtips, 10 µL</b>															
Natural ultra-microtip 309.0010B + R	x	x										x			
Natural ultra-microtip with filter 309.0010FR	x	x										x			
Natural microtip 302.0020B + R	x	x													
Natural microtip with filter 302.0010FR + AFB		x													
Natural gel loading tip 302.0010GR		x													
<b>microtips, 20 µL</b>															
Natural tip with filter 308.0020FS + FR			x	x	x <sup>1)</sup>	x <sup>1)</sup>							x <sup>1)</sup>		
Natural gel loading tip with filter 308.0020GFR			x	x	x <sup>1)</sup>	x <sup>1)</sup>									
<b>microtips, 100 µL</b>															
Natural tip with filter 308.0100FR					x	x							x		
Natural gel loading tip with filter 308.0100GFR					x	x	x <sup>1)</sup>								
<b>microtips, 200 µL</b>															
Natural universal tip 307.0200B + R			x	x	x	x	x						x	x	
Yellow universal tip 327.0200B + R			x	x	x	x	x						x	x	
Natural superior tip 308.0200B + R			x	x	x	x							x	x	
Natural tip 309.0200B + R			x	x	x	x	x						x	x	x <sup>1)</sup>
Yellow tip 329.0200B + R			x	x	x	x	x						x	x	x <sup>1)</sup>
Yellow tip 328.0200B + R			x	x											
Natural gel loading tip 308.0200GR			x	x	x	x									
Natural extended tip with filter 308.0200LFS + LFR							x								
<b>microtips, 300/350 µL</b>															
Natural tip 308.0350B + R					x	x	x							x	x
Natural tip with filter 308.0300FR + AFB							x							x	x
<b>microtips, 1000 µL</b>															
Natural universal tip 307.1000B + R								x							
Natural tip 309.1000B + R								x							
Blue tip 319.1000B + R								x							
Blue tip 318.1000B + R								x							
Natural tip with filter 309.1000FR + AFB + FS								x							
<b>macrotips</b>															
Macrotip 312.02 (2 mL)									x						
Macrotip 312.05B + R (5 mL)										x					
Macrotip 312.10 (10 mL)											x				

B = bag, F = filter, G = gel loading, L = long, R = rack, S = single wrapped, AF = autoclavable filter, ER = empty rack

<sup>1)</sup> Only to max. volume of the tip



# ACURA® electro 926 XS

2, 10, 10Y, 20 µL

50, 100 µL

200 µL

1000 µL

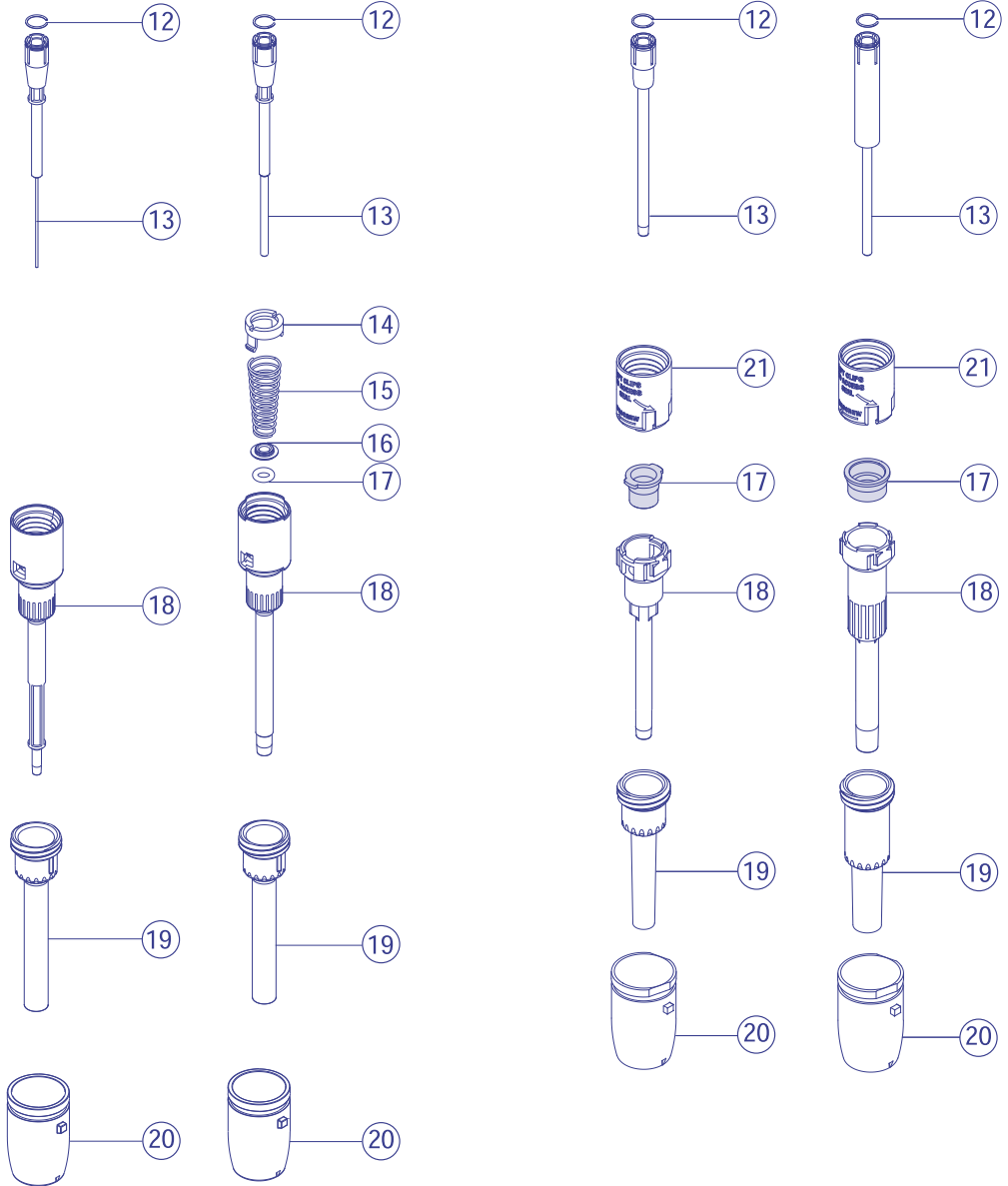

# REGULAR LENGHT VOLUMETRIC MODULE

2, 10, 10Y, 20  $\mu$ L

all other sizes

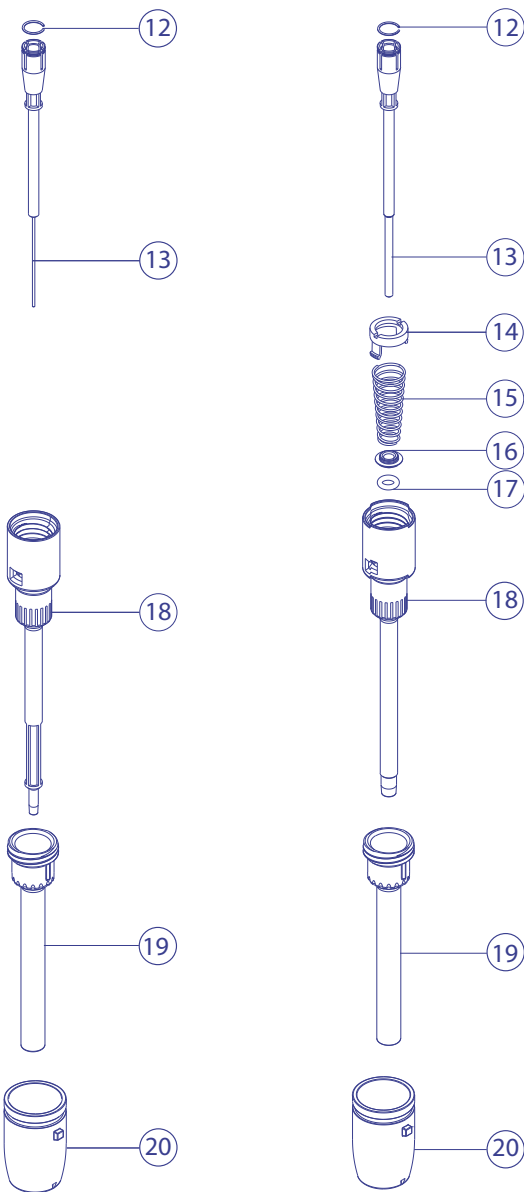

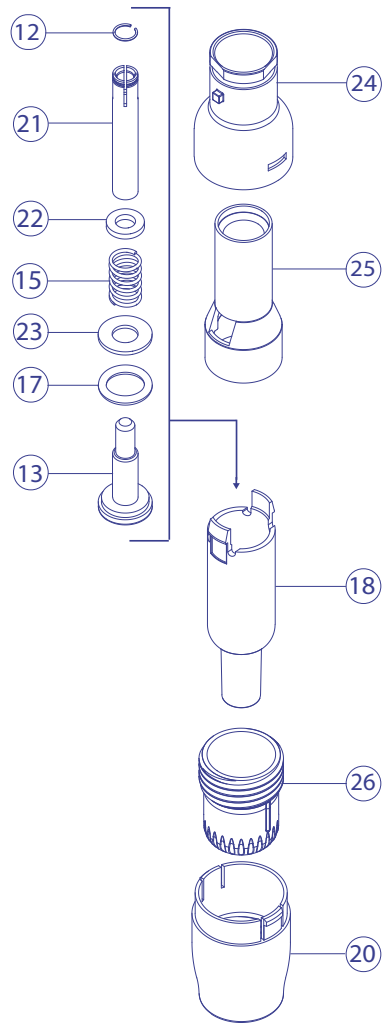
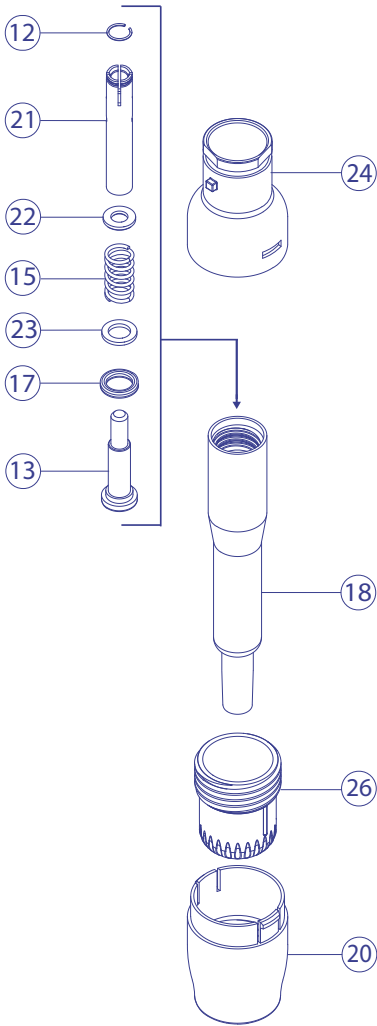

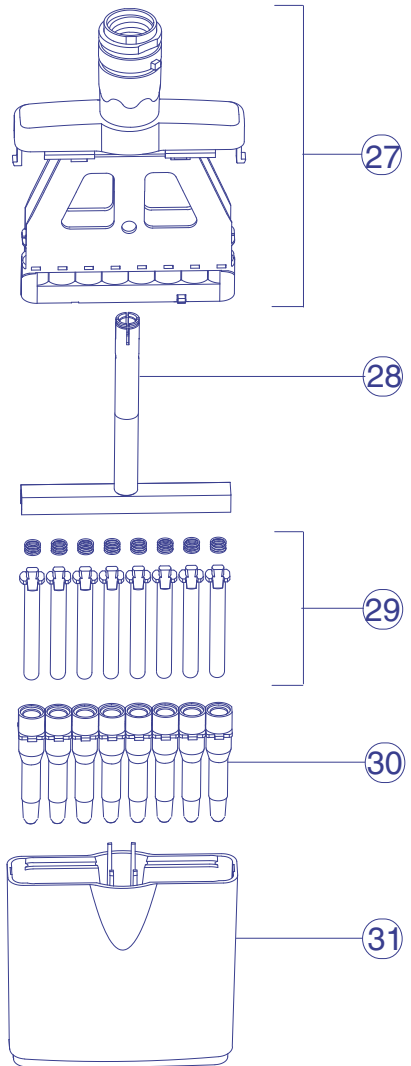
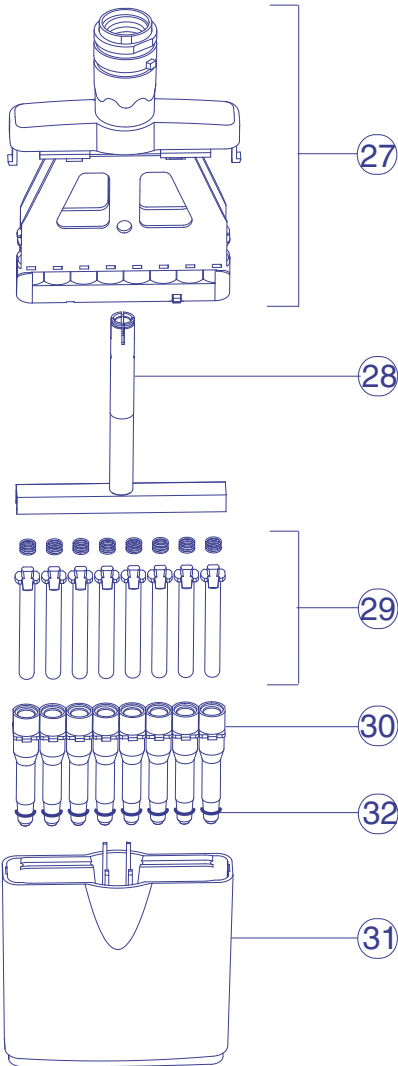

Operating instructions in other languages are available in digital format



U. S. F. C. C. part 15

