



AQUASEARCHER™

Photometers



For Quick and Easy Measurement of Water Samples in Field Applications

AquaSearcher AP50MM multi-function portable Photometer is designed intuitively to provide fast, reliable colorimetric and turbidity measurements. Its rugged single-handed design makes it perfect for field applications and the carrying case holds all test accessories. The AP50MM allows user to pre-program testing parameters to increase efficiency.

Unique Features:

- Fast and reliable tests - AP50MM is equipped with a real-time dynamic display for each measurement, to provide fast, reliable results. It can record up to 30,000 datapoints with time and date stamp.
- Intuitive operation- built-in calibration curves provide automatic selection of appropriate wavelengths from the long-lasting LED light source. Store commonly used tests for efficient field use.
- User-Friendly – large, backlit display makes it easier to read real-time results. Comes with a hard-shell carrying case with all accessories needed to perform tests in the field.

AQUASEARCHER™ Photometers

Specifications

Model	a-AP50MM
Source Lamp	Light Emitting Diode (LED)
Fixed wavelength	365.0 nm; 420.0 nm; 455.0 nm; 525.0 nm; 560.0 nm; 570.0 nm; 630.0 nm
Wavelength accuracy	± 1.0 nm
Wavelength Selection	Automatic
Photometric Accuracy	± 0.005 Abs @1.0 Abs Nominal
Photometric Measuring Range	0 – 1.0 Abs
Turbidity Excitation Wavelength	White and IR LED
Turbidity Optical System	Nephelometric (90° scattered light)
Turbidity Measuring Range	0 – 200 NTU
Turbidity Reproducibility	1 NTU
Turbidity Detection Limit	1 NTU
Sample Cell Compatibility	Round Ø24 mm; Round Ø16 mm with adapter
Data Storage	30,000 Group with Date, Time
Display	Backlit Graphical LCD, 160 × 240 pixels
Power	4 AA (LR6) Batteries (Included)
Battery Life	6 months (typical) @25 readings a week
Working Environment (metric)	4 – 41 °C , 85% RH, non-condensing
Working Environment (imp.)	40 – 106 °F, 85% RH, non-condensing
Storage Temperature	-18 – 60 °C (0 – 140 °F)
Dimensions (L x W x H)	265 × 88 × 62 mm
Net Weight (imp.)	1.32 lbs (Basic unit)
Net Weight (metric)	0.6 kg (Basic unit)
Approvals	CE marked / RoHS Compliant

Packages

Available in two configurations

a-AP50MM-B
30853394
(1) a-AP50MM-B Photometer

a-AP50MM-F
30853393
(1) a-AP50MM-B Photometer
(4) AA Batteries
(2) 24 mm replacement vials, 10 mL
(2) 24 mm replacement vials, 25 mL
(1) COD Adapter, for a-AP50MM
(1) Briefcase AQUASEARCHER

Outline Dimensions

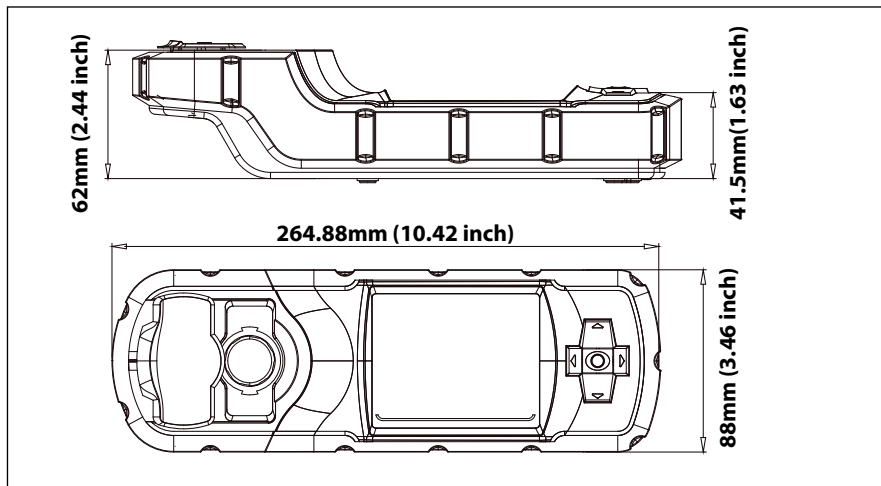

Other Features and Equipment

- **Application Mode:** Multiparameter colorimetric and turbidity measurement
- **Additional Features:** EPA180.1.

Compliance

- **Metrology:** CE / FCC CLASS-A

Accessories

24 mm replacement vials pk/5, 10 mL.....	30853486
24 mm replacement vials pk/5, 25 mL.....	30853487
COD Adapter, for a-AP50MM.....	30853488
Briefcase AQUASEARCHER.....	30744416
Cleaning brush pk/5	30727772
Cloth pk/4	30727773
Screwdriver pk/2	30727774
Cylinder 5 mL pk/2	30727776

80776871_A 20230807 © Copyright OHAUS Corporation

OHAUS CORPORATION

Tel: 800.672.7722
973.377.9000
Fax: 973.944.7177

www.ohaus.com

The management system governing the manufacture of this product is ISO 9001:2015 certified.

